

A-A (2 : 1)

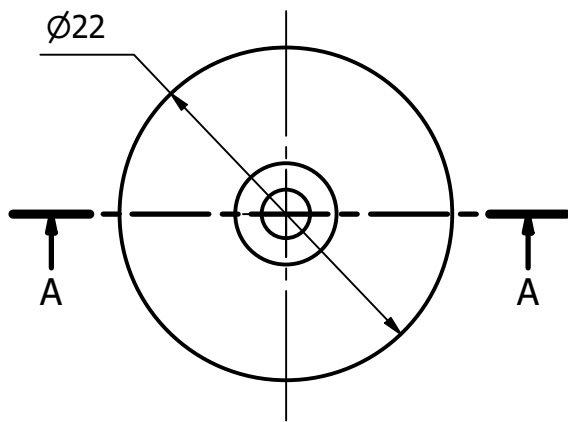

Fissaggio con viti testa svasata
a norma DIN 965 - ISO 7046

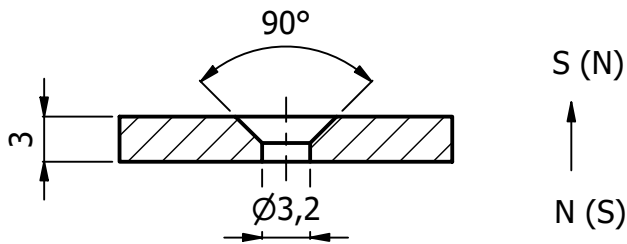

Rev.	Descrizione modifiche	Data	Firma

Disegnato M.D.	Data 23/10/2023	Materiale Neodimio	Trattamento Nichelato	Tolleranza +/- 0.1	Unità mm
-------------------	--------------------	-----------------------	--------------------------	-----------------------	-------------

ITALFIT magneti

Via Comelli, 39
33034 Fagagna (Ud)
Tel 0432/801675 Fax 0432/810197
P.IVA e C.F. 02610340305

Descrizione
Magnete con foro svasato - magnetizzazione assiale (N+S)

Codice
NS01.35NI00.2233

Scala
2 : 1

Formato
A4